

FS 22-3

CONTI® Single Convolution Air Spring

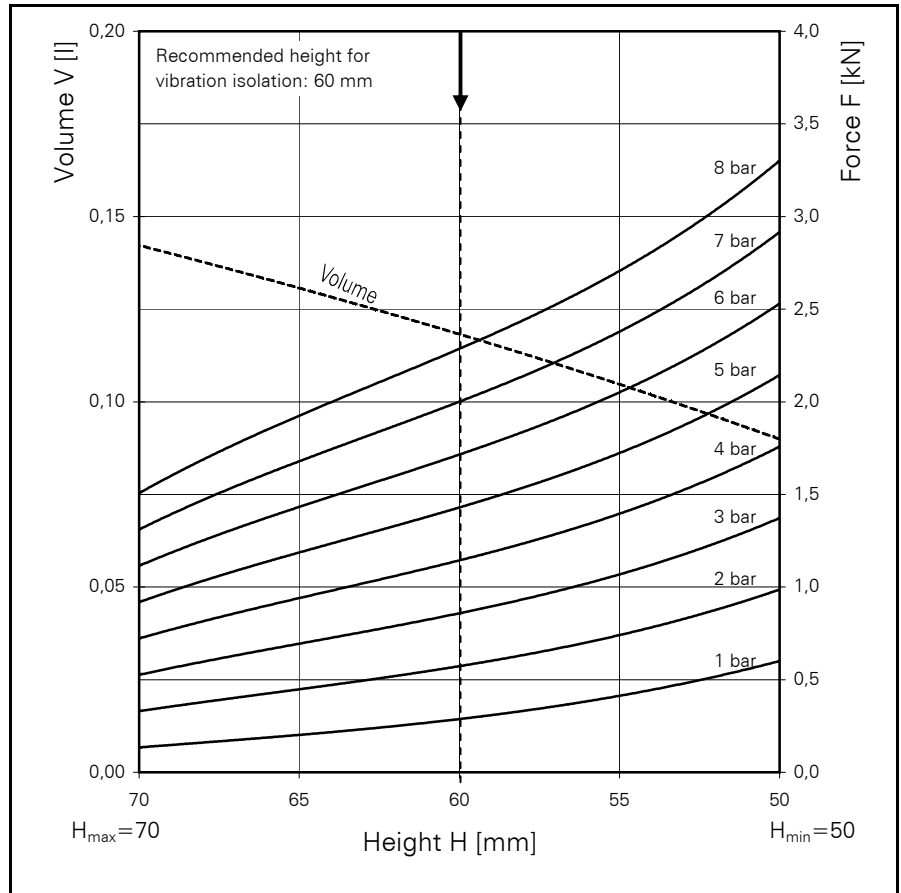
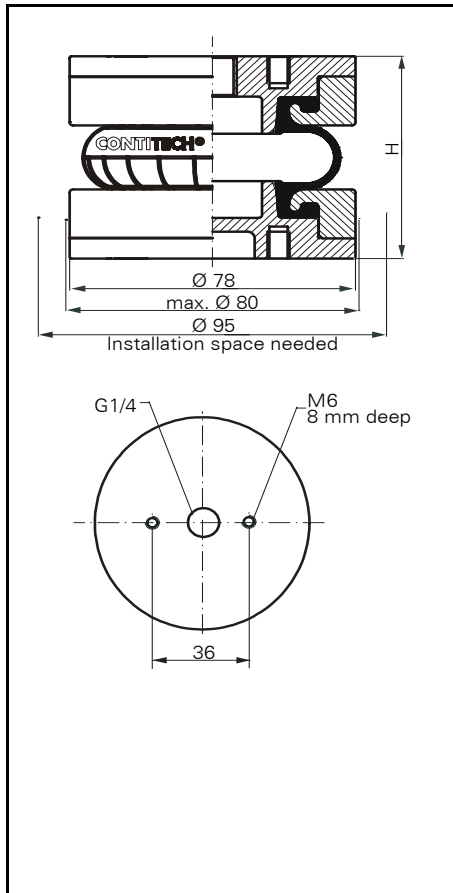

FS 22-3

Force-height diagram

Purchase order data

Type	Order No.
Rubber bellows only	on request
With aluminium plates	50604
G 1/4 air inlet	

Additional types on request

Technical data

Min. pressure	0 bar
Return force to min. height	≤ 120 N
Overall weight with clamped plates	0.5 kg

Vibration isolation - dynamic characteristic values

Design height H: recommended 60mm, minimum 55mm

Pressure p [bar]	3	4	5	6	7	8	Vol. V[l]
Force (Load) [kN]	0.88	1.19	1.48	1.80	2.11	2.40	
Spring rate [N/cm]	635	820	995	1190	1370	1570	
Natural frequency [Hz]	4.3	4.2	4.2	4.1	4.1	4.1	

Pneumatic application - static characteristic values

Force F [kN]

Pressure p [bar]	3	4	5	6	7	8	Vol.[l]	
Height H [mm]	70	0.52	0.72	0.92	1.12	1.32		0.15
	65	0.70	0.94	1.18	1.43	1.67		0.13
	60	0.87	1.15	1.44	1.72	2.01		0.12
	55	1.06	1.39	1.72	2.05	2.38		0.10



Service instructions
 M6 = 15 Nm
 G 1/4 = 25 Nm